

Fig. 1.
p. 3.

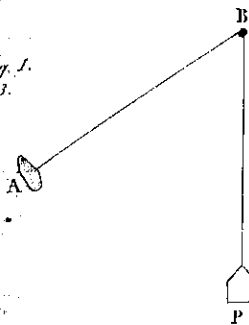

Fig. 2.
p. 3.



Fig. 3.
p. 4.

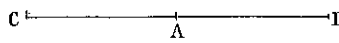

Fig. 4.
p. 5.

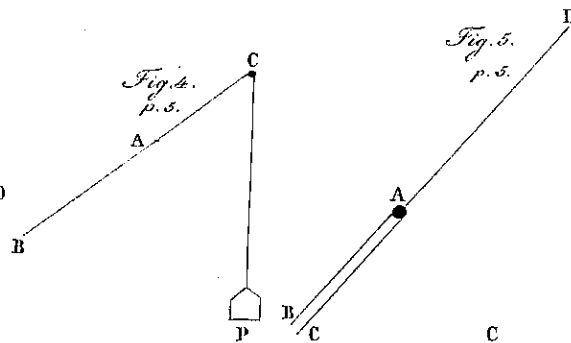

Fig. 5.
p. 5.

Fig. 6.
p. 5.

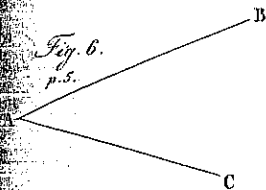

Fig. 7.
p. 5.

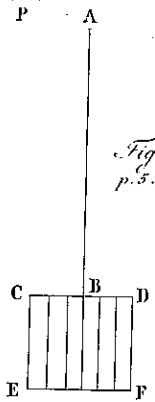

Fig. 8.
p. 5.

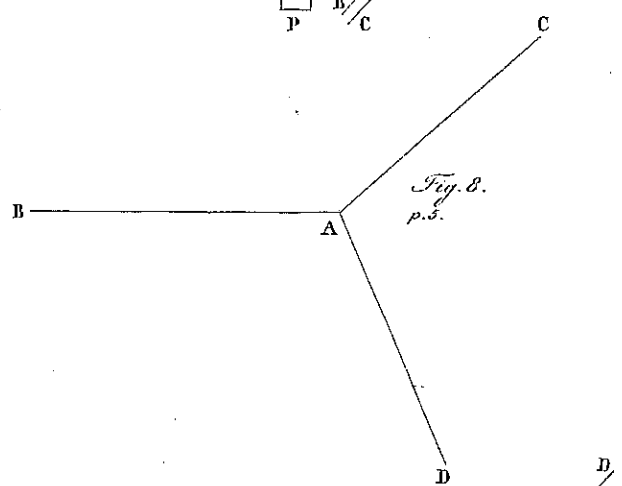

Fig. 9.
p. 5.

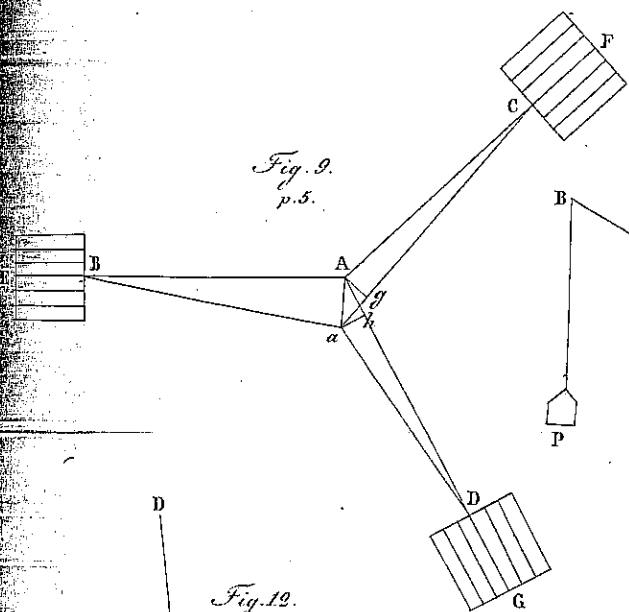

Fig. 10.
p. 6.

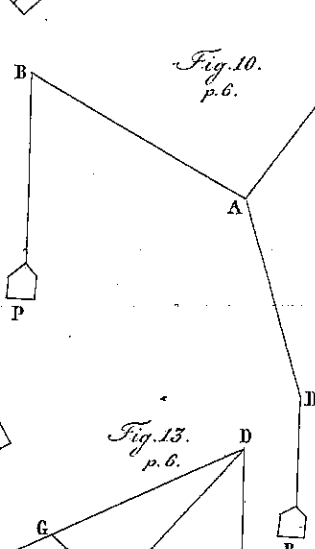

Fig. 11.
p. 6.

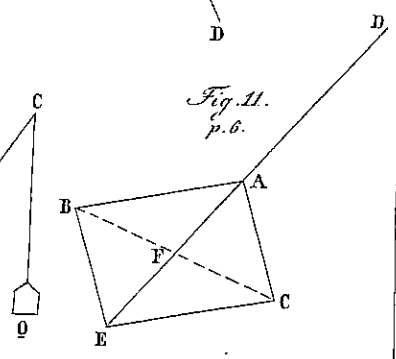

Fig. 12.
p. 6.

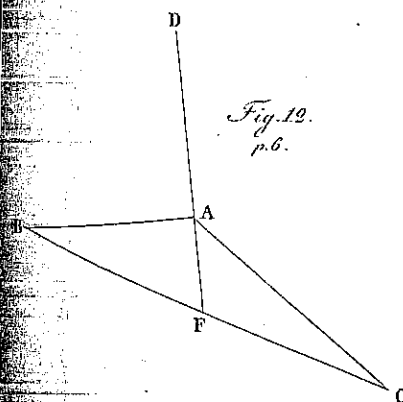

Fig. 13.
p. 6.

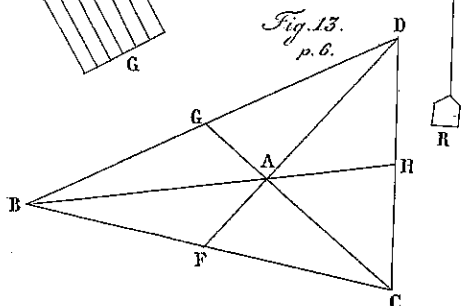

Fig. 14.
p. 6.

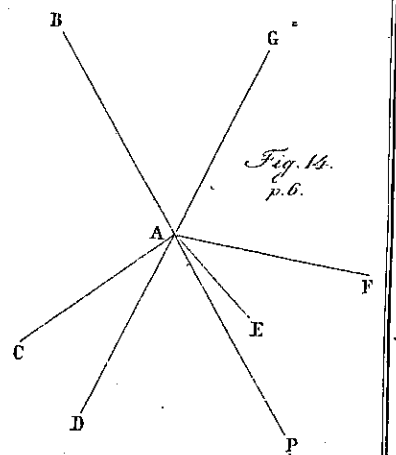

Fig. 15.
p. 7.

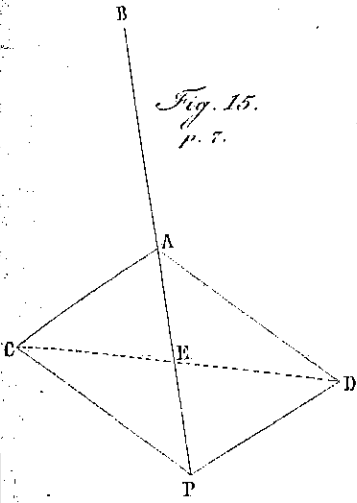

Fig. 16.
p. 7.

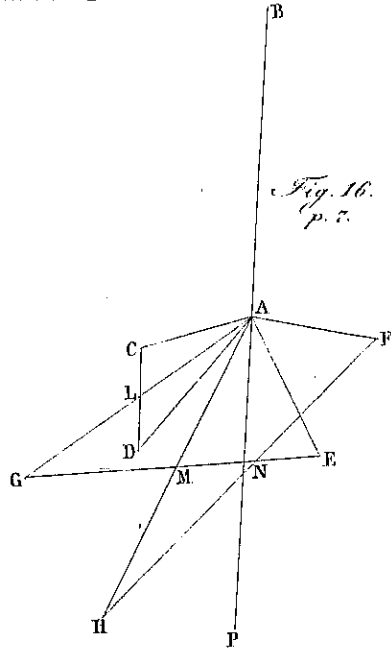

Fig. 17.
p. 7.

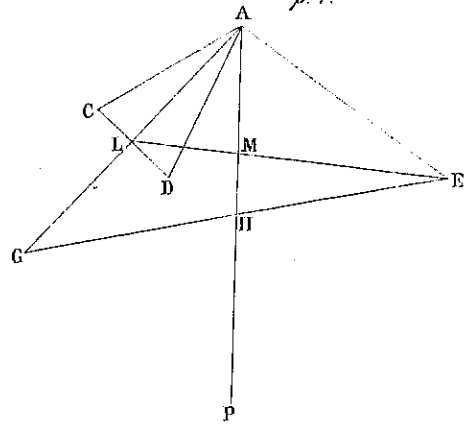

Fig. 20.
p. 9.

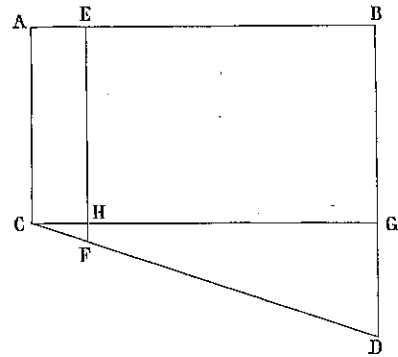

Fig. 18.
p. 8.

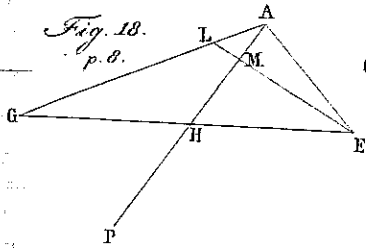

Fig. 25. p. 10.

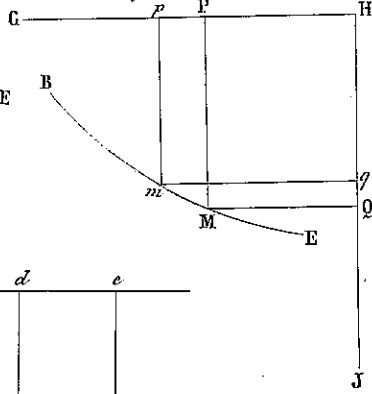

Fig. 21. p. 9.

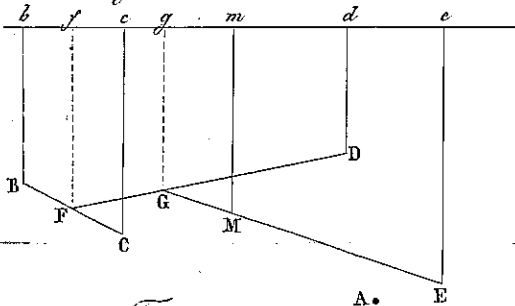

Fig. 19.
p. 8.

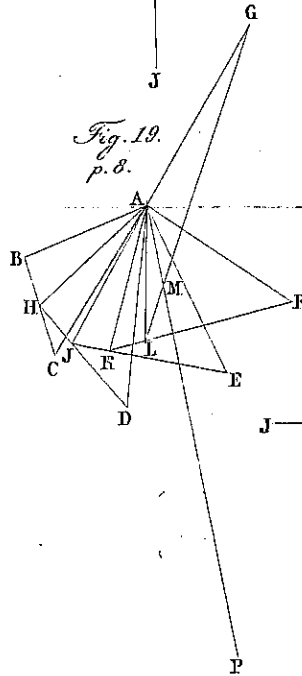

Fig. 24.
p. 10.

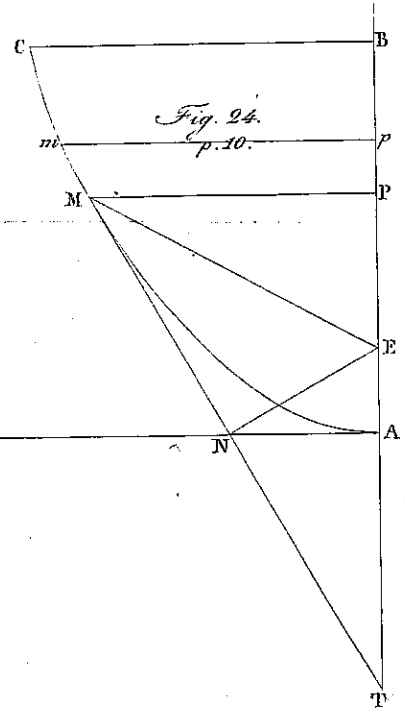

Fig. 22. p. 10.

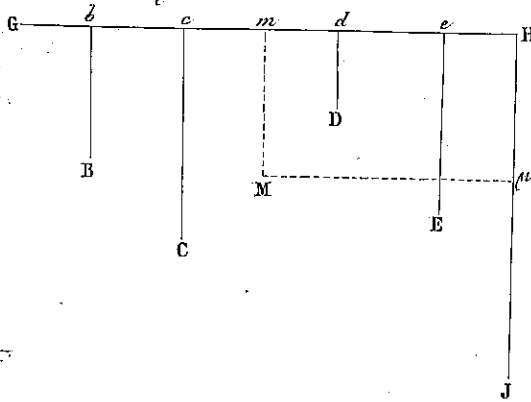

Fig. 25. p. 11.

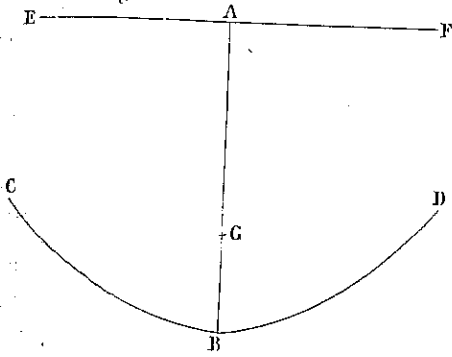

Fig. 20. p. 11.

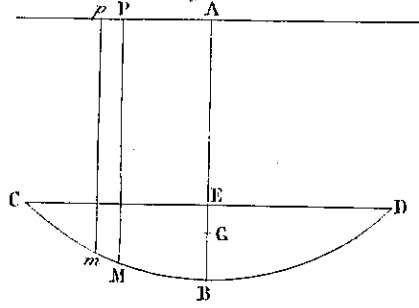

Fig. 27. p. 11.

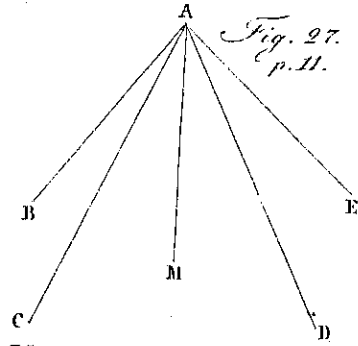

Fig. 55. p. 15.

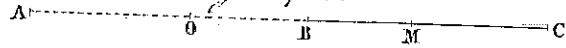

Fig. 28. p. 11.

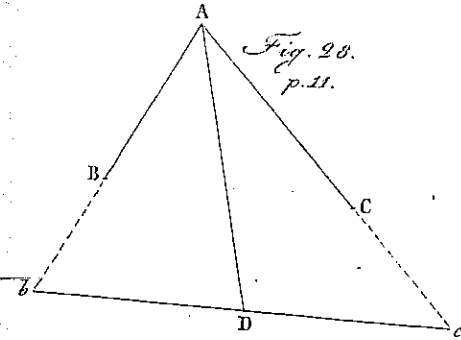

Fig. 50. p. 12.

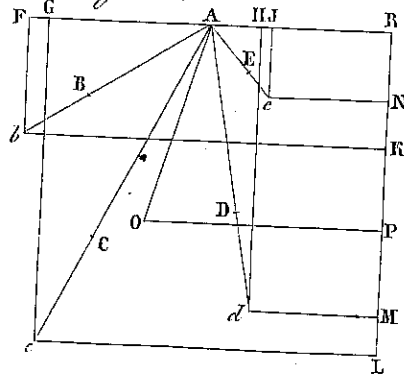

Fig. 51. p. 12.

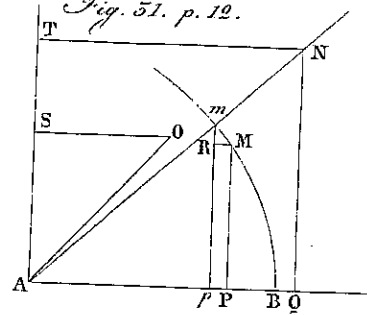

Fig. 52. p. 15.

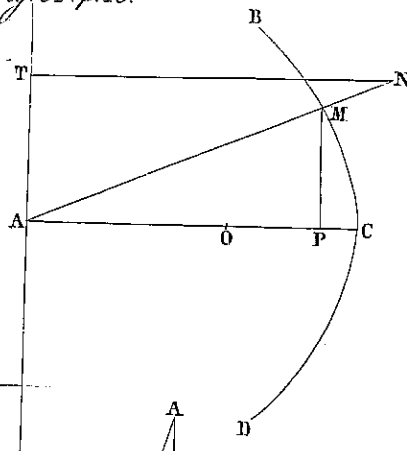

Fig. 55. p. 15.

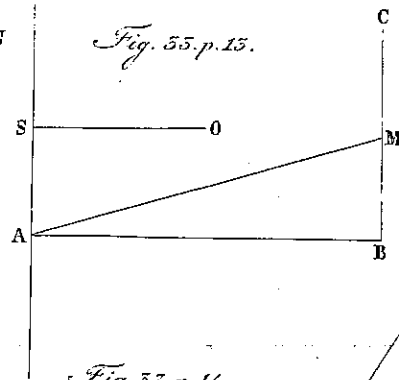

Fig. 54. p. 15.

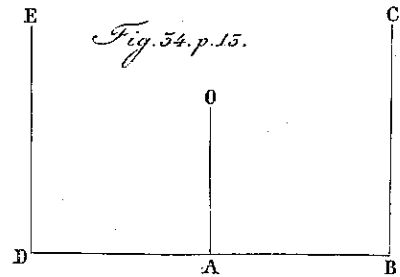

Fig. 56. p. 14.

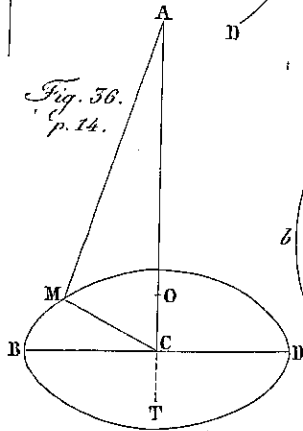

Fig. 57. p. 14.

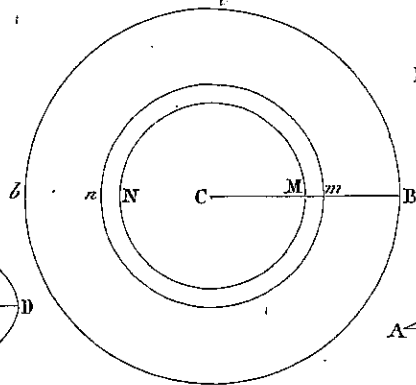

Fig. 29. p. 11.

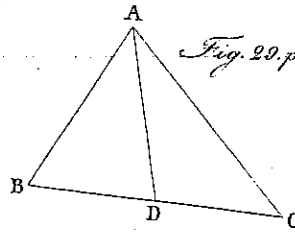

Fig. 59. p. 16.

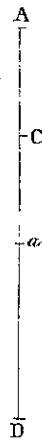

Fig. 58. p. 14.

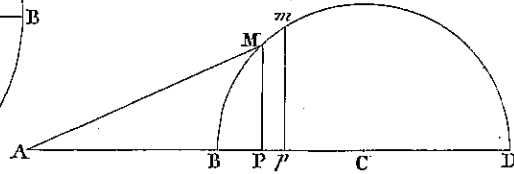

Fig. 40.
p. 16.

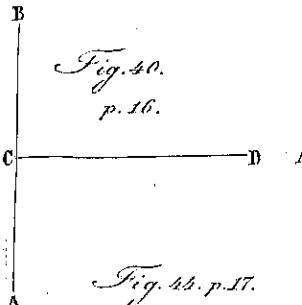

Fig. 41. p. 17.

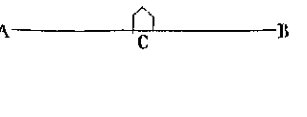

Fig. 42. p. 17.

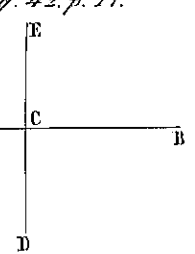

Fig. 43. p. 17.

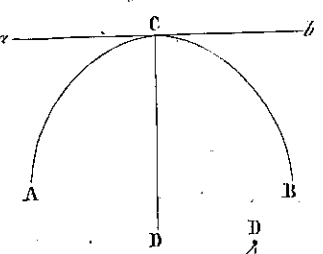

Fig. 44. p. 17.

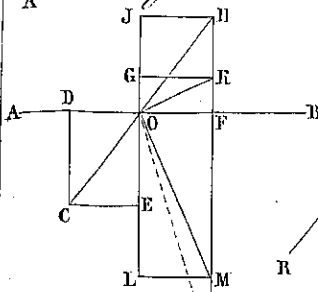

Fig. 45.
p. 18.

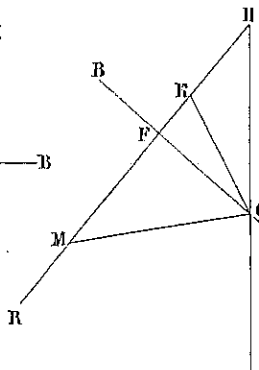

Fig. 46. p. 18.

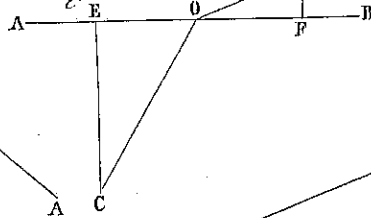

Fig. 47.
p. 18.

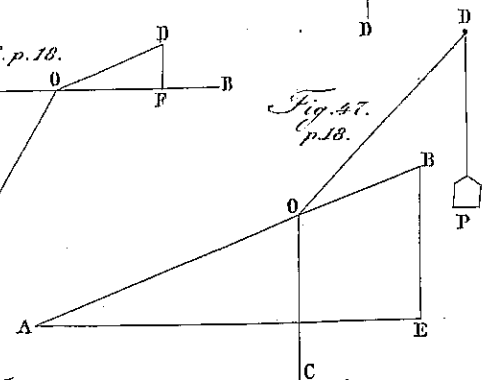

Fig. 48.
p. 18.

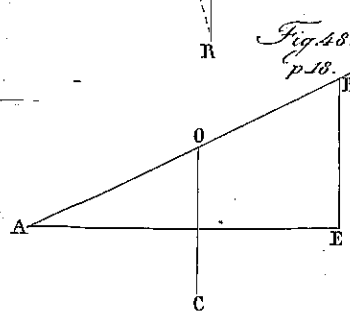

Fig. 49.
p. 18.

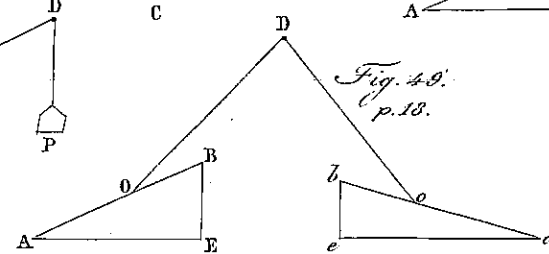

Fig. 50.
p. 19.

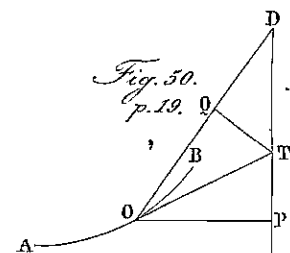

Fig. 51.
p. 19.

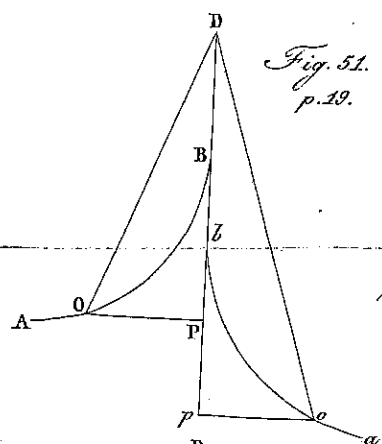

Fig. 52.
p. 20.

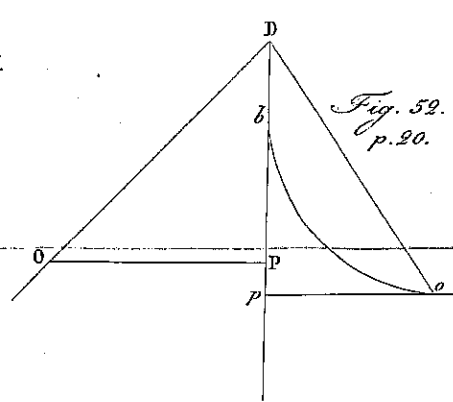

Fig. 53.
p. 20.

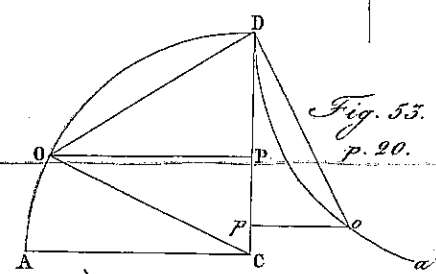

Fig. 54.
p. 20.

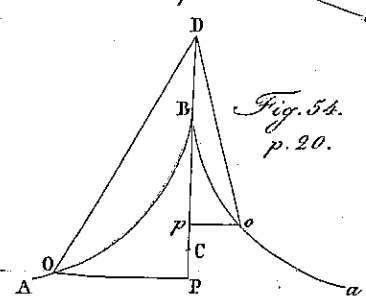

Fig. 55.
p. 21.

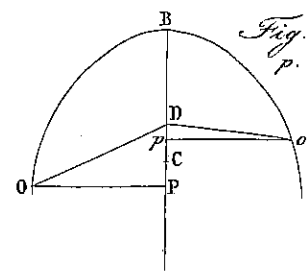

Fig. 56.
p. 21.

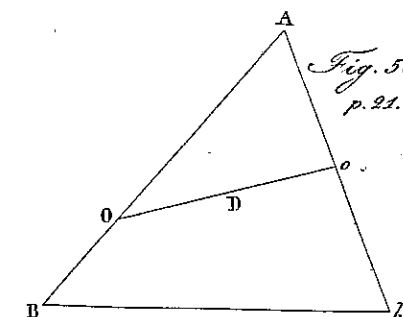

Fig. 57.
p. 21.

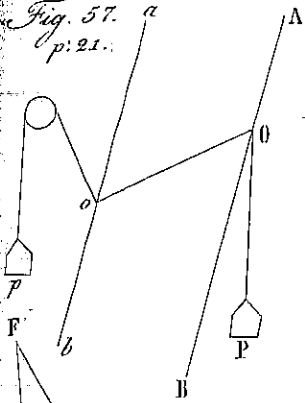

Fig. 58. p. 21.

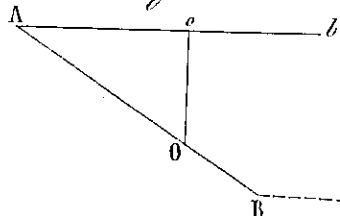

Fig. 59.
p. 21.

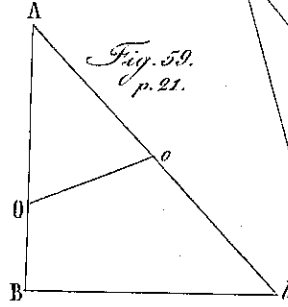

Fig. 60.
p. 21.

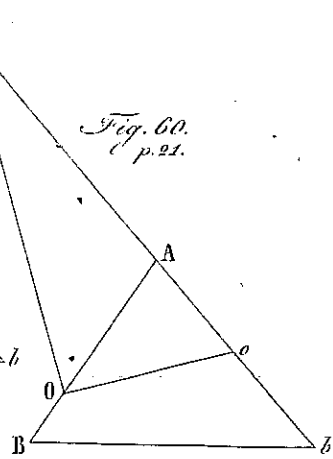

Fig. 61.
p. 22.

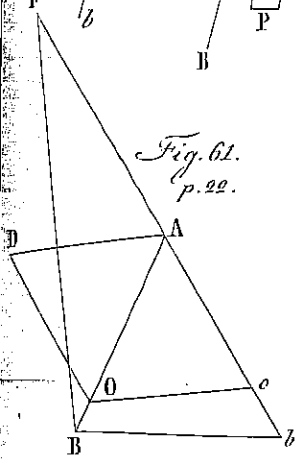

Fig. 62.
p. 22.

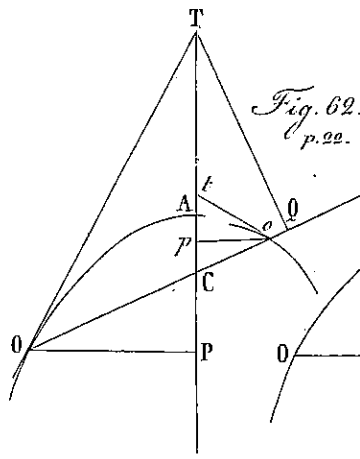

Fig. 63. p. 22.

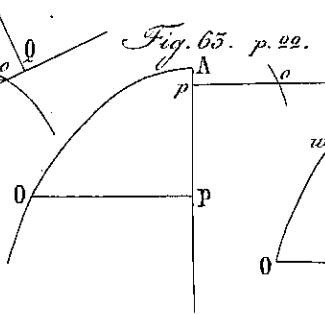

Fig. 64.
p. 23.

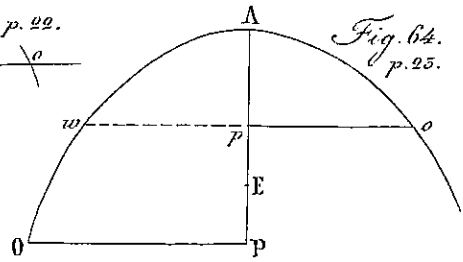

Fig. 65. p. 23.

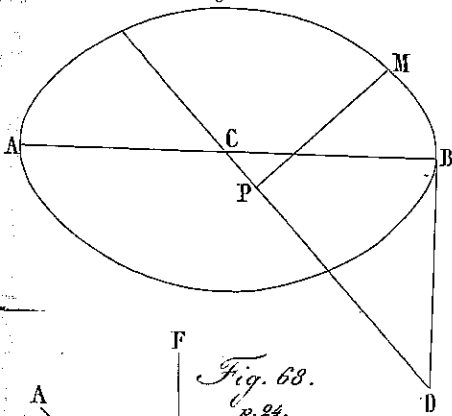

Fig. 66.
p. 25.

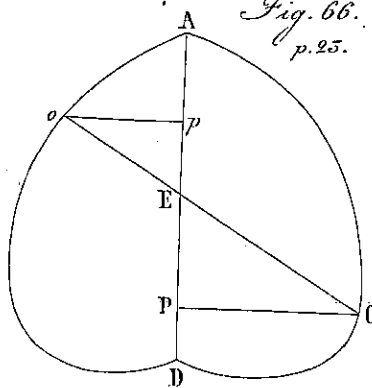

Fig. 67.
p. 24.

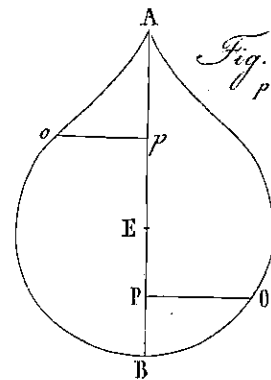

Fig. 68.
p. 24.

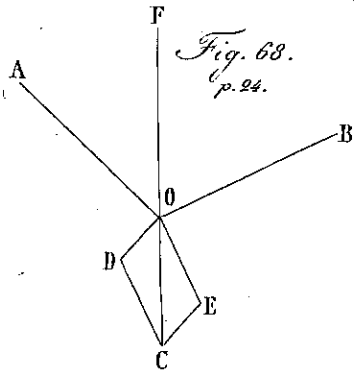

Fig. 69.
p. 24.

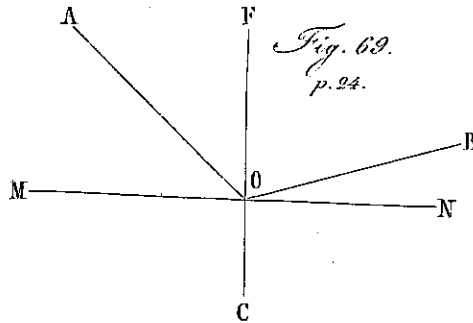

Fig. 70.
p. 24.

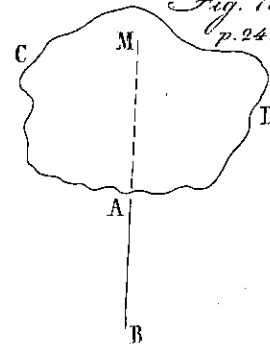

Fig. 71. p. 24.

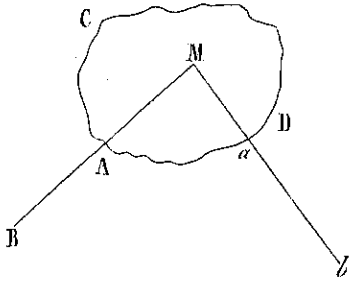

Fig. 72. p. 25.

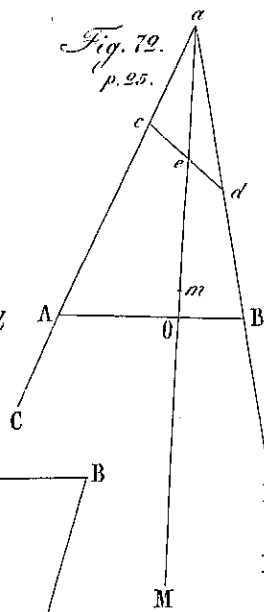

Fig. 73. p. 25.

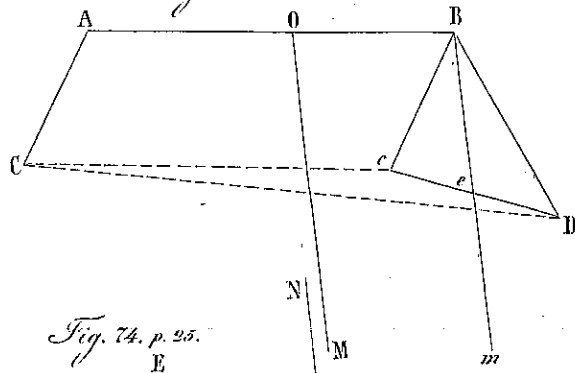

Fig. 75. p. 25.

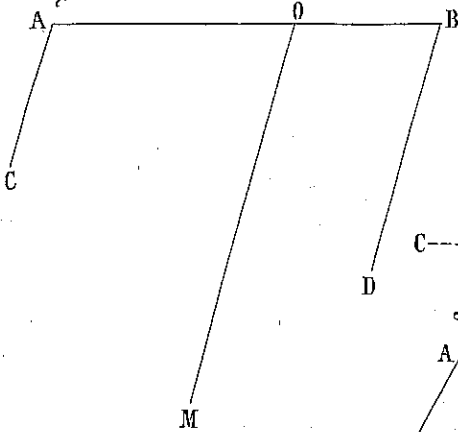

Fig. 74. p. 25.

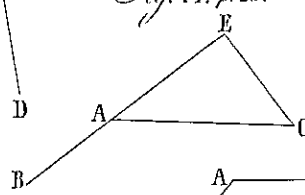

Fig. 76. p. 26.

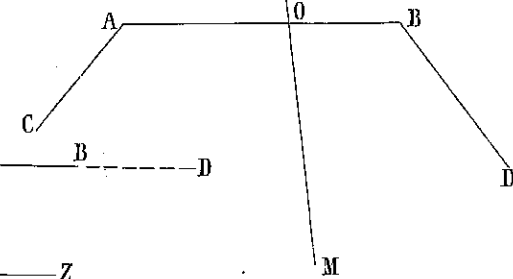

Fig. 77. p. 26.

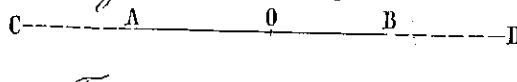

Fig. 79. p. 26.

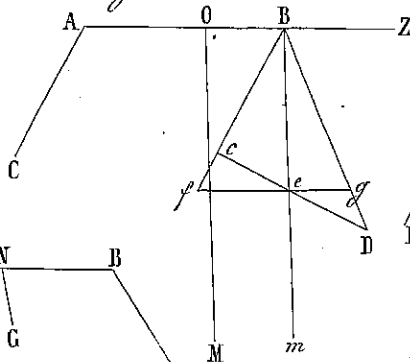

Fig. 80. p. 27.

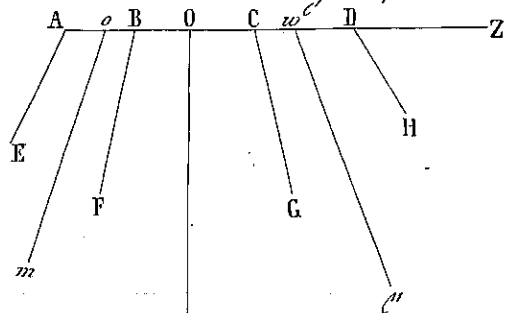

Fig. 78. p. 26.

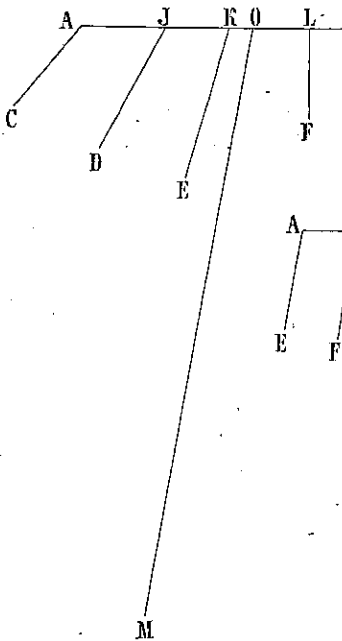

Fig. 81. p. 27.

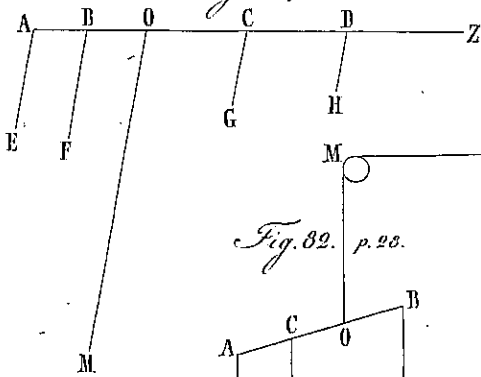

Fig. 82. p. 28.

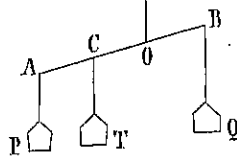

Fig. 83. p. 28.

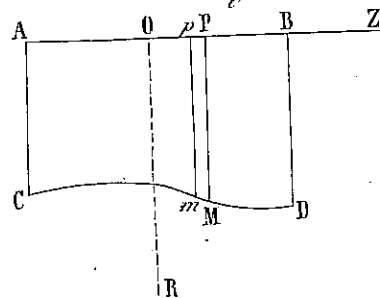

Fig. 84. p. 29.

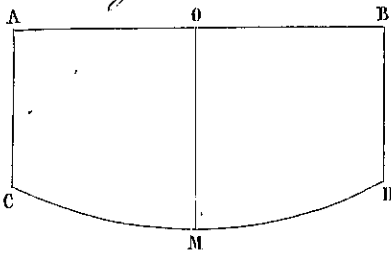

Fig. 85. p. 29.

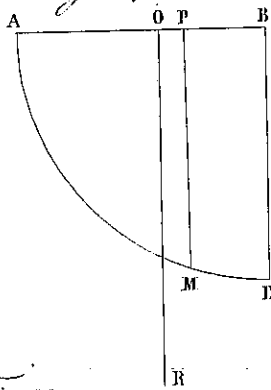

Fig. 86. p. 29.

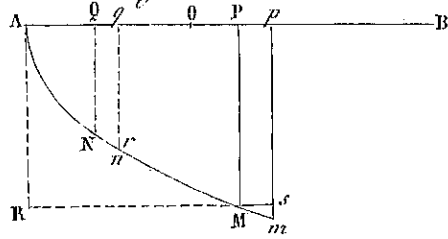

Fig. 87. p. 50.

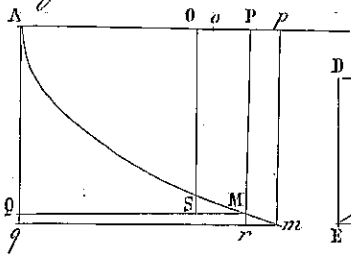

Fig. 88. p. 50.

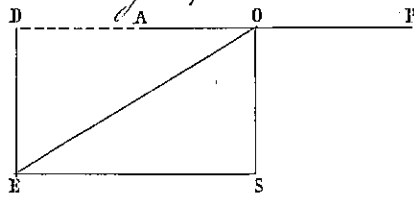

Fig. 89. p. 51.

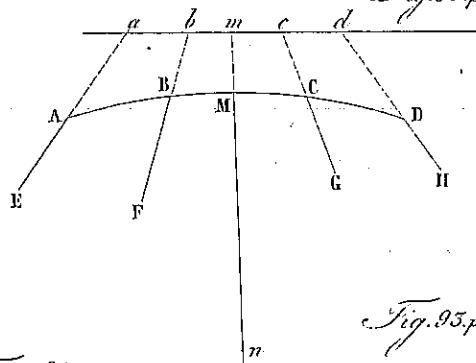

Fig. 90. p. 51.

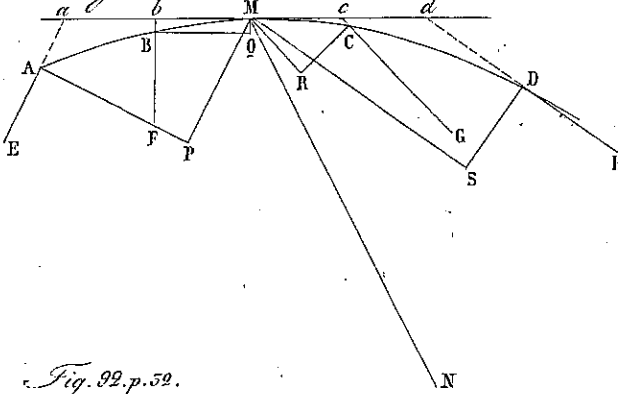

Fig. 91. p. 52.

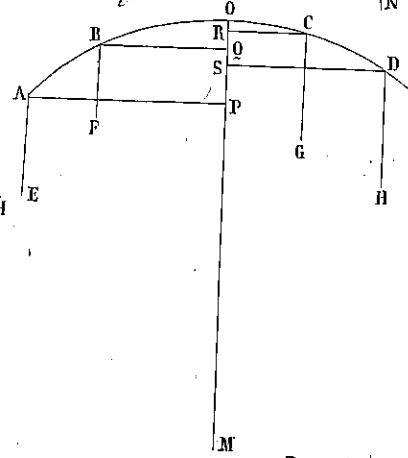

Fig. 93. p. 52.

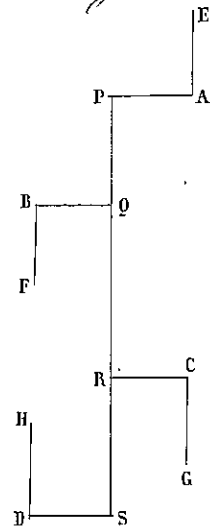

Fig. 92. p. 52.

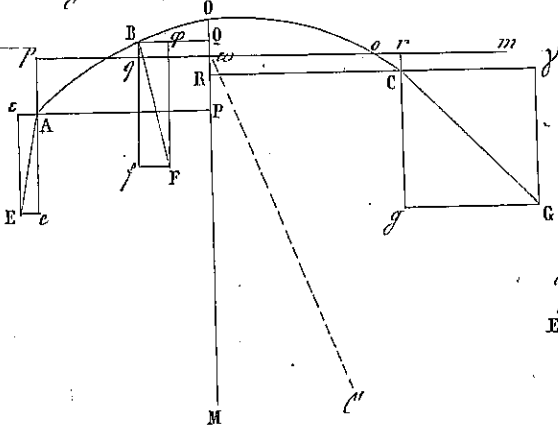

Fig. 94. p. 52.

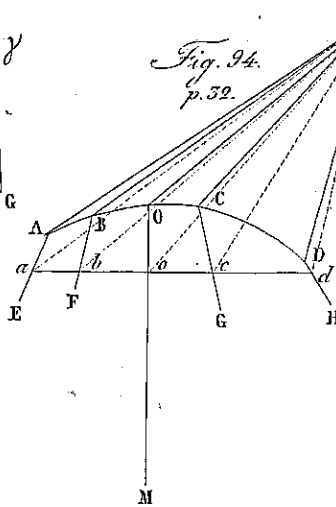

Fig. 95. p. 52.

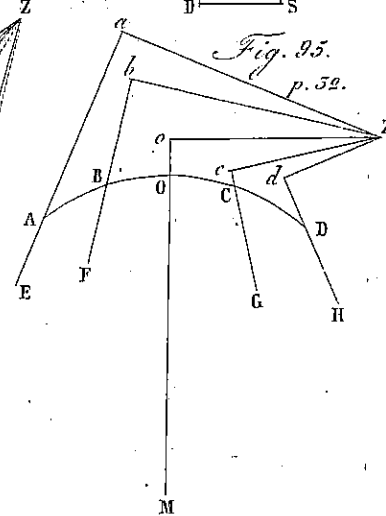

Fig. 97. p. 55.

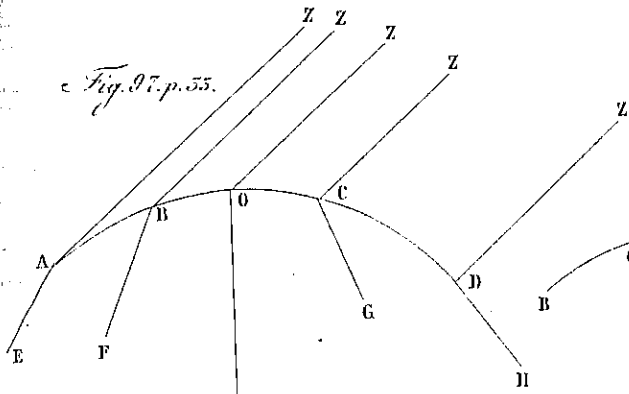

Fig. 102. p. 54.

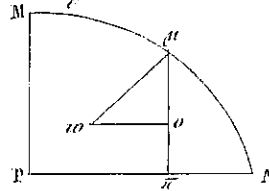

Fig. 101. p. 54.

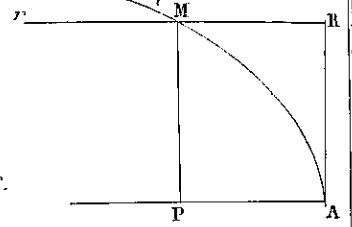

Fig. 107. p. 56.

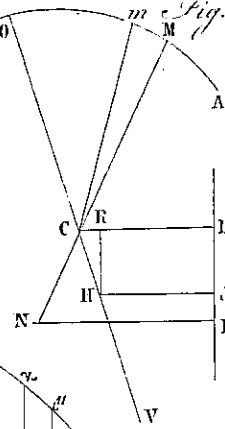

Fig. 105. p. 55.

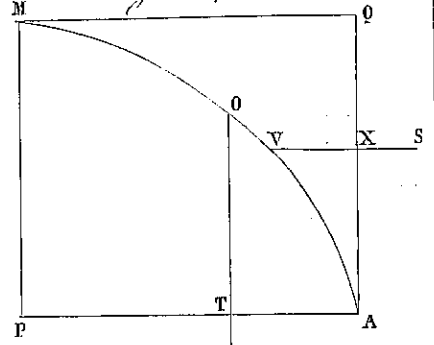

Fig. 99. p. 55.

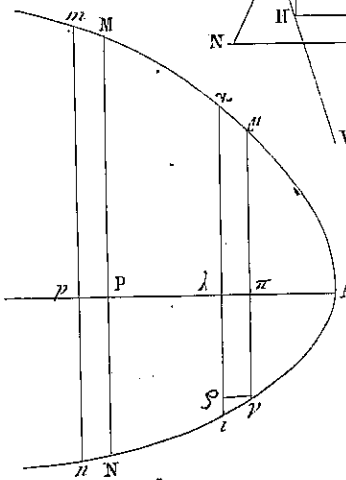

Fig. 100. p. 54.

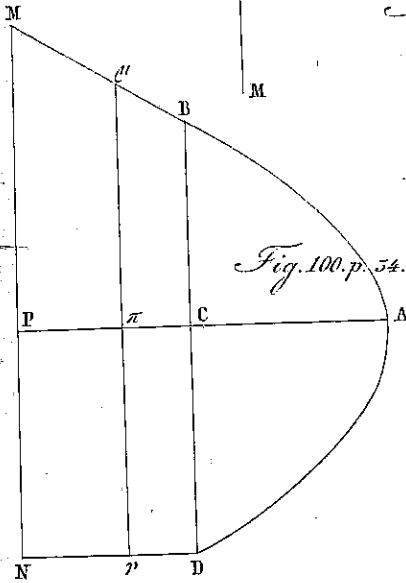

Fig. 104. p. 55.

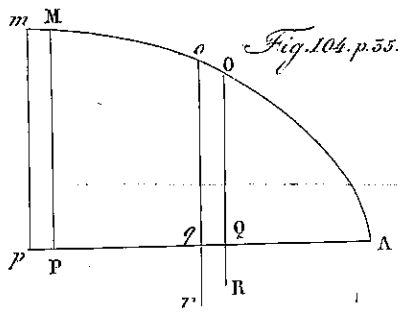

Fig. 96. p. 55.

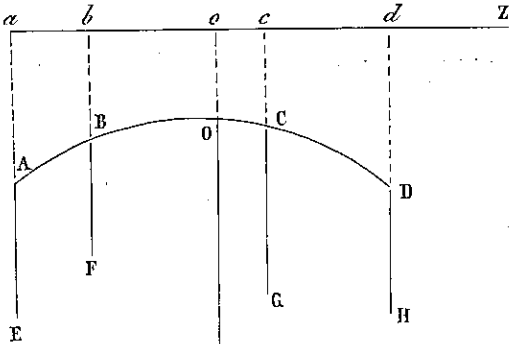

Fig. 105. p. 54.

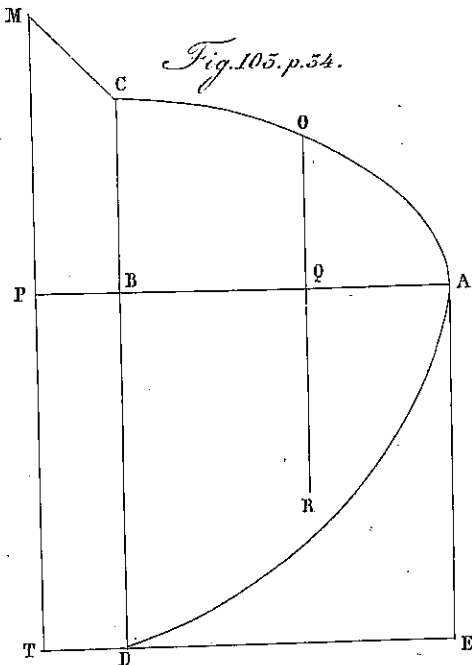

Fig. 106. p. 55.

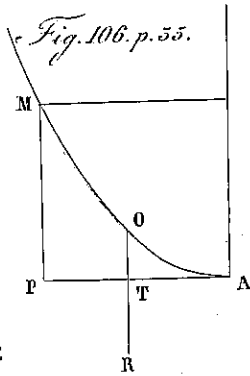

Fig. 98. p. 55.

